



Product Information
Version 1.1

ZEISS Axio Imager 2

Your Open Microscope System for Automated Material Analysis



Your Open Microscope System for Automated Material Analysis

- › **In Brief**
- › The Advantages
- › The Applications
- › The System
- › Technology and Details
- › Service

Axio Imager 2 from ZEISS is your system platform tailored to demanding materials analysis tasks, development of new materials as well as quality control. You always profit from crisp images and high optical performance. This applies in particular to sophisticated contrasting techniques, e.g. like the Circular Differential Interference Contrast (C-DIC) and polarization contrast. Use the motorized stand to achieve reproducible illumination settings and, consequently, constant image quality. You always obtain comparable results and high productivity by automating your workflow. Axio Imager 2 offers a high degree of adaptability in line with your future requirements. The stands are open to expand and cover a wide range of applications.

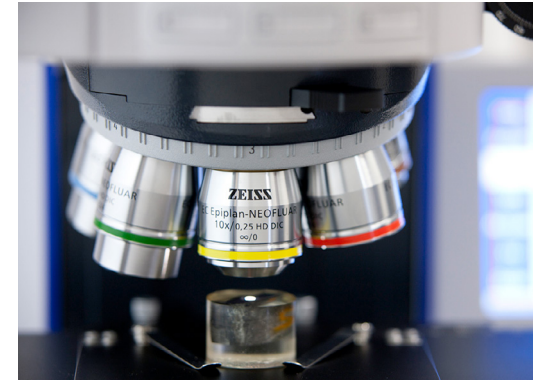

Simpler. More Intelligent. More Integrated.

- › In Brief
- › **The Advantages**
- › The Applications
- › The System
- › Technology and Details
- › Service

Profit from an Open Microscope System

Whether in research, testing or failure analysis, materials microscopy faces quite various challenges. With Axio Imager 2 from ZEISS you will be able to meet and win these challenges. Attach application-specific components and perform e.g. particle analysis, investigate non-metallic inclusions (NMI), liquid crystals or semiconductor-based MEMs. Axio Imager 2 supports the correlative workflow to electron microscopic investigations, too.

Experience Competence in all Contrasting Techniques

Choose from a variety of contrasting techniques to achieve an optimum image quality for your dedicated applications. Examine your samples in reflected light in brightfield, darkfield, Differential Interference Contrast (DIC), Circular Differential Interference Contrast (C-DIC), polarization or fluorescence contrast. For transmitted light you can choose between brightfield, darkfield, Differential Interference Contrast (DIC), polarization or circular polarization. Minimized stray light enables homogenous illumination. You achieve outstanding image contrast, even at high magnifications.

Achieve Reliable, Reproducible Results

Stability is essential if you want to obtain good results. You will appreciate the stable imaging conditions of Axio Imager 2, especially when working with high magnifications and performing time dependent studies. Due to the motorization of Axio Imager 2 you will achieve quick and reproducible results while you always work under constant conditions. For instance, the motorized apertures and the illumination control, which automatically adjusts the color temperature via filter wheels.



Stage insert with correlative sample holder for a big variety of specimen.

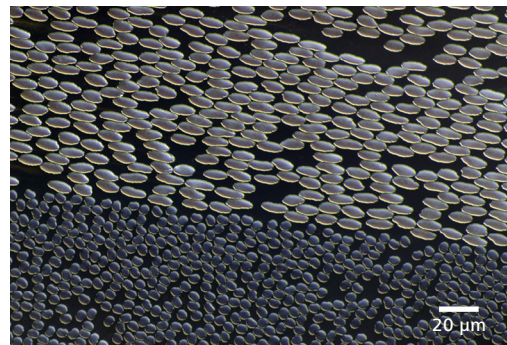

Carbon fiber-reinforced polymer (CFRP), Differential Interference Contrast (DIC); Objective: EC Epiplan-NEOFLUAR 50x/0.8



Appreciate the stable imaging conditions with Axio Imager 2.

Expand Your Possibilities

- › In Brief
- › **The Advantages**
- › The Applications
- › The System
- › Technology and Details
- › Service

Experience Competence in all Contrasting Techniques

Brightfield and Darkfield: Maximum Homogeneity and a Stray Light Free Image Background

In brightfield Axio Imager 2 provides homogeneous illumination and exceptional contrast. By minimizing disturbing stray light and reducing the longitudinal color aberration of the illumination optics, the darkfield illumination contrast is suitable for the most challenging samples and impresses even when faced with finest structures. Switching between the techniques only requires a simple turn. The motorized stands allow you to work particularly quickly and conveniently.

C-DIC: Perfect for All Structures

Circular Differential Interference Contrast (C-DIC) is a polarization-optical technique which, in contrast to ordinary Differential Interference Contrast (DIC), uses circularly polarized light. This technique has a number of decisive advantages for the contrasting of differently aligned object structures. The specimen no longer has to be rotated for best image

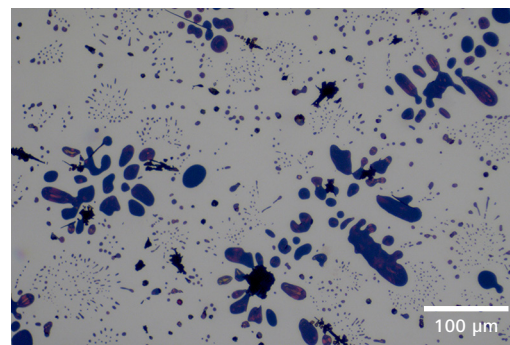

Copper casting, brightfield.
Objective: EC Epiplan-NEOFLUAR 20×/0.5

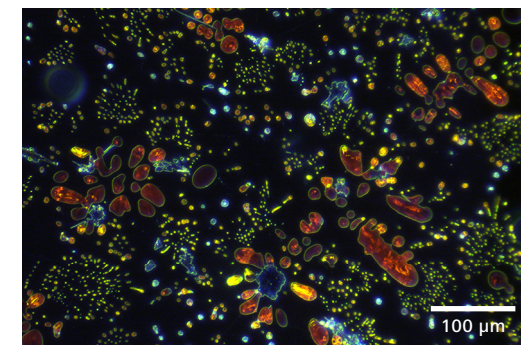

Copper casting, darkfield.
Objective: EC Epiplan-NEOFLUAR 20×/0.5

contrast and quality, as it is the case in basic DIC. With C-DIC it is simply enough to adjust the position of the C-DIC prism to achieve best image quality whether it is for contrast and/or resolution independent of sample orientation. And all this is possible using one C-DIC prism for a homogeneous unsurpassed quality image.

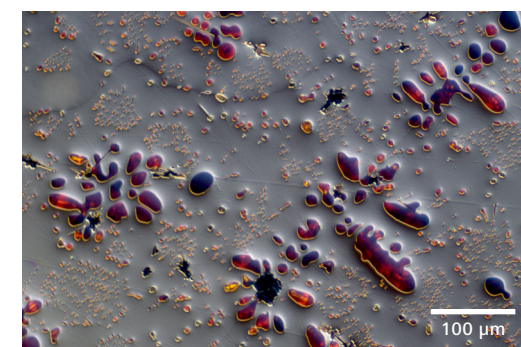

Copper casting, C-DIC.
Objective: EC Epiplan-NEOFLUAR 20×/0.5

Expand Your Possibilities

- › In Brief
- › **The Advantages**
- › The Applications
- › The System
- › Technology and Details
- › Service

Experience Competence in All Contrasting Techniques

Brightfield

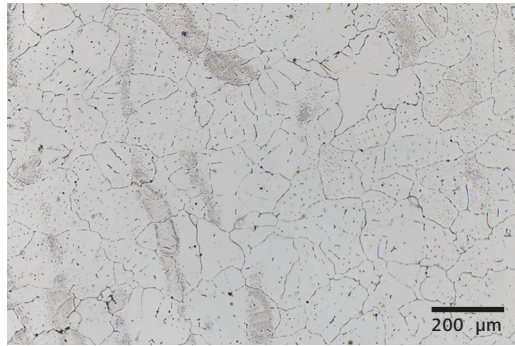

Darkfield

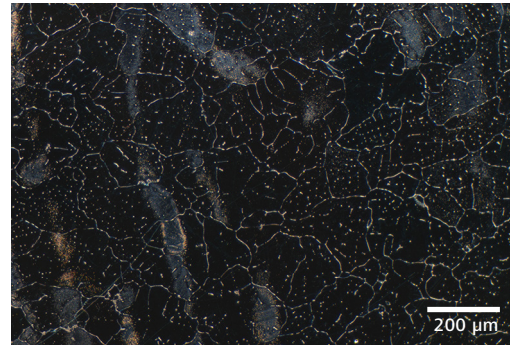

C-DIC

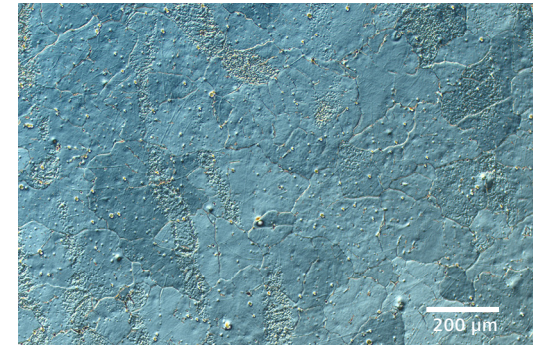

Polarization Contrast

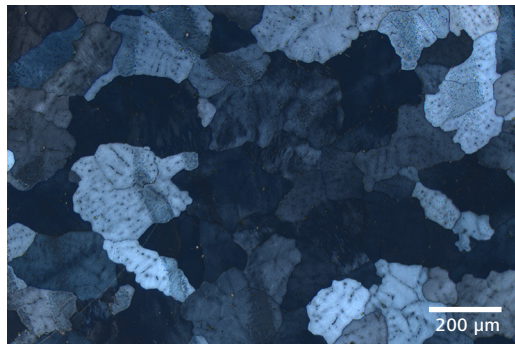

Polarization with Additional Lambda Plate

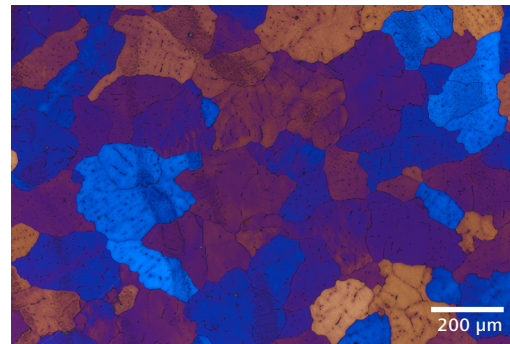

Contrasting Technique	Reflected Light	Transmitted Light
Brightfield	●	●
Darkfield	●	●
DIC	●	●
C-DIC	●	
Fluorescence	●	
Phase contrast		●
Polarization	●	●

Sample: pure aluminum; Objective: EC Epiplan-NEOFLUAR 10x/0.25, same position acquired with different contrasting techniques

Tailored Precisely to Your Applications

- › In Brief
- › The Advantages
- › **The Applications**
- › The System
- › Technology and Details
- › Service

Industry, Typical Applications, Typical Samples	Task	ZEISS Axio Imager 2 Offers
Automotive Industry	<ul style="list-style-type: none"> ■ Quality control and development of compound materials ■ Quality control of welded joints ■ Examination of inclusions and cracks ■ Determination of grain sizes and non-metallic inclusions ■ Particle Analysis 	<ul style="list-style-type: none"> ■ Hardware Auto Focus ■ Correlative microscopy and AxioVision module Shuttle & Find ■ Polarization contrast and C-DIC ■ AxioVision modules: Grains, Graphite, NMI, Multiphase ■ AxioVision module: Particle Analyzer
Aviation and Space Industry	<ul style="list-style-type: none"> ■ Quality control and development of compound materials ■ Quality control of welded joints ■ Examination of inclusions and cracks ■ Determination of grain sizes and non-metallic inclusions 	<ul style="list-style-type: none"> ■ Hardware Auto Focus ■ Correlative microscopy and AxioVision module Shuttle & Find ■ Polarization Contrast and C-DIC ■ AxioVision Module: Grains, Graphite, Multiphase
Metal Producing and Processing Industry	<ul style="list-style-type: none"> ■ Examination of inclusions and cracks ■ Determination of grain sizes and non-metallic inclusions ■ Analysis of anisotropic materials 	<ul style="list-style-type: none"> ■ Hardware Auto Focus ■ Correlative microscopy and AxioVision module Shuttle & Find ■ Polarization Contrast and C-DIC ■ AxioVision Module: Grains, Graphite, Multiphase, NMI
Oil, Gas and Mining Industry	<ul style="list-style-type: none"> ■ Analysis of texture and microstructure ■ Analysis of pores ■ Fluorescence analysis ■ 2D- and 3D-Imaging 	<ul style="list-style-type: none"> ■ Laser Scanning Microscope LSM 800 ■ Correlative microscopy and AxioVision module Shuttle & Find
Particle Analysis	<ul style="list-style-type: none"> ■ Inspection of cleanliness acc. to ISO 16232, VDA 19 ■ Determination of residual contamination of oil and lubricants acc. to ISO 4406, ISO 4407, SAE AS 4059 	<ul style="list-style-type: none"> ■ AxioVision module Particle Analyzer
Correlative Microscopy	<ul style="list-style-type: none"> ■ Combination of information from light- and electron microscope ■ Fast relocation of Regions of Interest 	<ul style="list-style-type: none"> ■ Correlative microscopy and AxioVision module Shuttle & Find

Tailored Precisely to Your Applications

- › In Brief
- › The Advantages
- › **The Applications**
- › The System
- › Technology and Details
- › Service

Industry, Typical Applications, Typical Samples	Task	ZEISS Axio Imager 2 Offers
Non-metallic Inclusions (NMI)	Quantitative and qualitative analysis of microstructure of steel Determination of purity of steel Investigation of content and distribution of non-metallic inclusions based on color, brightness, shape and formation Evaluation of inclusions with comparative diagrams Precise identification of sulfides and oxides acc. to DIN 50602, EN 10247, ASTM E45, ISO 4967 and JIS G 0555	AxioVision module NMI
3D-Topography	Measurement of roughness Detection of height differences Measurement of thickness of transparent coatings, surface characteristics, color and gloss	Laser Scanning Microscope LSM 800
Temperature Microscopy	Examination of temperature influence on behavior of metals, crystals, ceramics and polymers Identification of phase transformations Determination of temperature for phase transition Determination of melting point	Linkam heating stages and software module Linkam for Axio Vision and ZEN 2 core

ZEISS Axio Imager 2 at Work

- › In Brief
- › The Advantages
- › **The Applications**
- › The System
- › Technology and Details
- › Service

Aviation and Space Industry

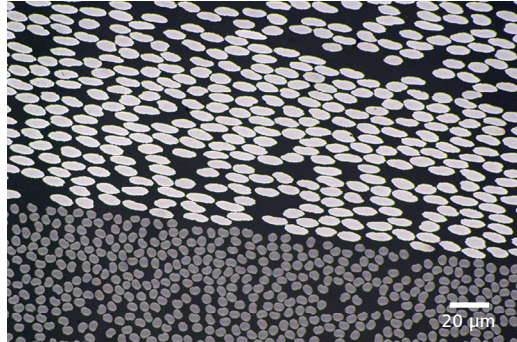

Carbon fiber-reinforced polymer (CFRP), brightfield,
objective: EC Epiplan-NEOFLUAR 50×/0.8

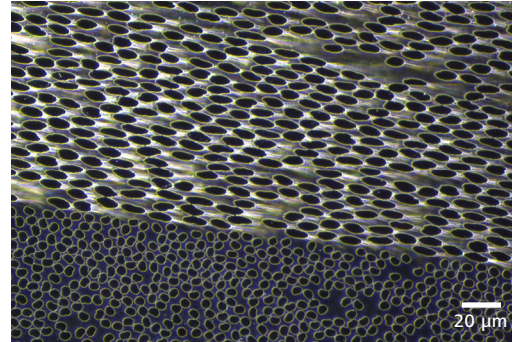

Carbon fiber-reinforced polymer (CFRP), darkfield,
objective: EC Epiplan-NEOFLUAR 50×/0.8

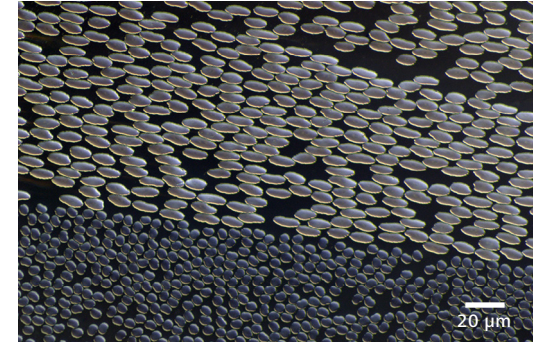

Carbon fiber-reinforced polymer (CFRP), DIC,
objective: EC Epiplan-NEOFLUAR 50×/0.8

Metal Producing and Processing Industry

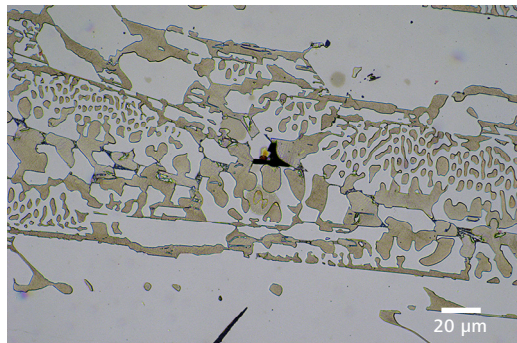

Raw iron, brightfield,
objective: EC Epiplan-NEOFLUAR 50×/0.8

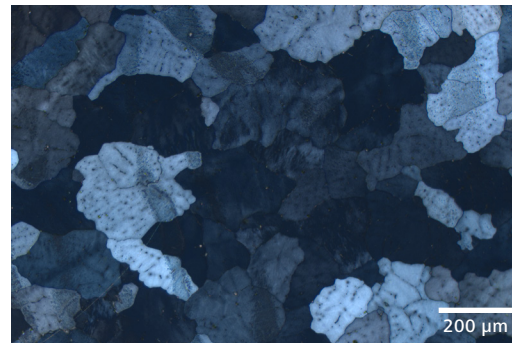

Aluminium, polarization,
objective: EC Epiplan-NEOFLUAR 10×/0.25

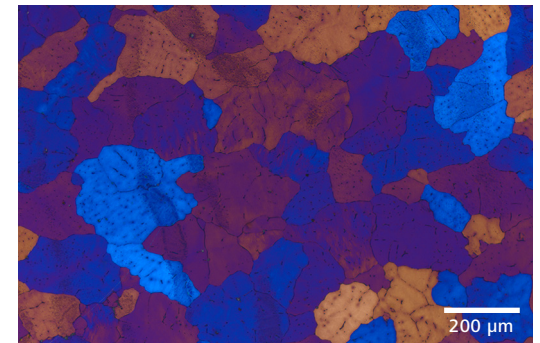

Aluminium, polarization with Lambda plate,
objective: EC Epiplan-NEOFLUAR 10×/0.25

ZEISS Axio Imager 2 at Work

- › In Brief
- › The Advantages
- › **The Applications**
- › The System
- › Technology and Details
- › Service

Oil, Gas and Mining Industry

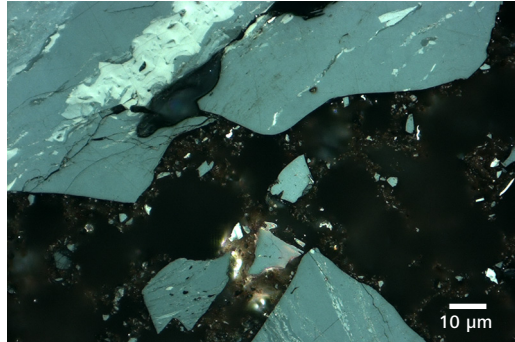

Vitrinite,
objective: EC Epiplan-NEOFLUAR 50×/1.0 Oil Pol

Automotive Industry

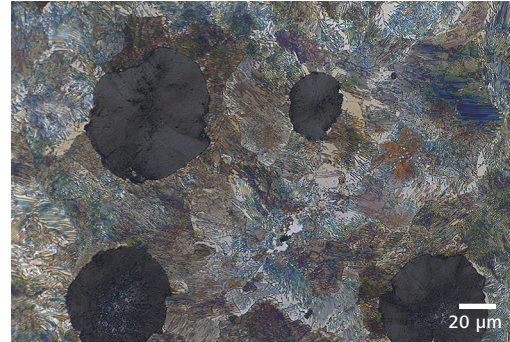

Cast iron, brightfield,
objective: EC Epiplan-APOCHROMAT 50×/0.95

Particle Analysis



Particle analysis, brightfield,
objective: EC Epiplan-NEOFLUAR 20×/0.5

Expand Your Possibilities

- › In Brief
- › The Advantages
- › The Applications
- › **The System**
- › Technology and Details
- › Service

Analyze Tiny Particles: Accurately and Reproducibly

Particle Analyzer is a milestone for your quality control. With the fully motorized light microscope Axio Imager 2 you measure particles down to 2 μm .

Particle Analyzer software supports the standards for cleanliness testing ISO 16232, VDA 19, and oil analysis ISO 4406, ISO 4407, and SAE AS 4059. With the system solutions from ZEISS, you ensure that the required microscope settings are always selected correctly. You receive reliable, reproducible results nearly independent of the user carrying out the analysis. By carrying out correlative particle analyzes, you expand the depth of information contained within your findings to include the results of element and materials characterization.

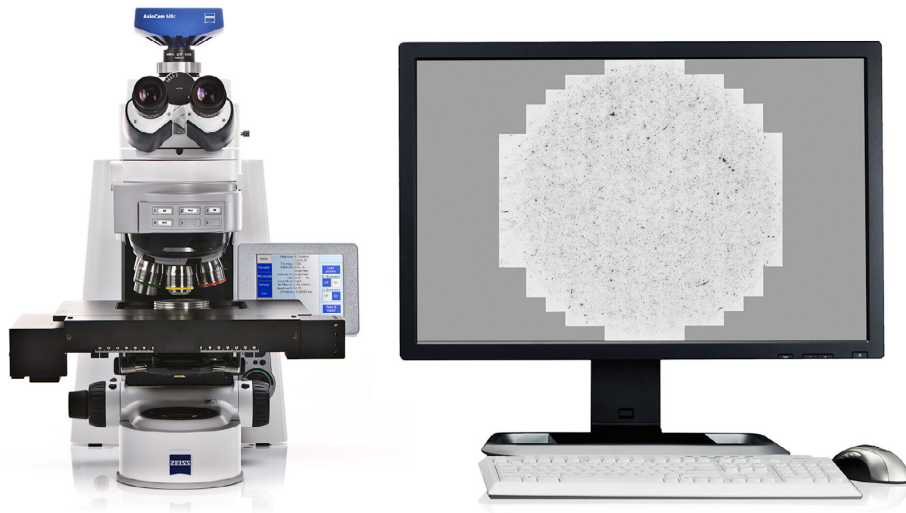

Expand Your Possibilities

- › In Brief
- › The Advantages
- › The Applications
- › **The System**
- › Technology and Details
- › Service

Correlative Automated Particle Analysis (CAPA): More Knowledge. Higher Quality.

Completely characterize residual dirt particles with Correlative Automated Particle Analysis from ZEISS. Detect particles with your Axio Imager 2 and relocate preselected particles automatically, using your SEM from ZEISS. Perform an EDX analysis to reveal information of their elemental composition. Correlative Particle Analyzer automatically documents the results from both, the light microscopic and electron microscopic analysis. You receive a combined, informative report at the touch of a button.

As an experienced user, you can inspect the results of the combined light microscopic and electron microscopic analysis on an interactive overview screen. Retrieve particles at the touch of a button, automatically start new EDX analyzes, and automatically generate a report. With Correlative Particle Analyzer, your results will be available up to ten times faster than first conducting an analysis with a light microscope and then sub-sequently with an electron microscope. You can systematically focus on potentially process-critical particles. The complementary material characterization from both microscopic worlds gives you added security.



Correlative sample holder for efficient relocation of particles in your ZEISS scanning electron microscope.

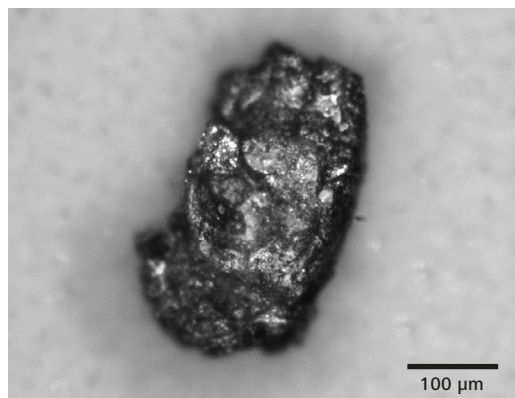

Image of a metallic particle from a light microscope

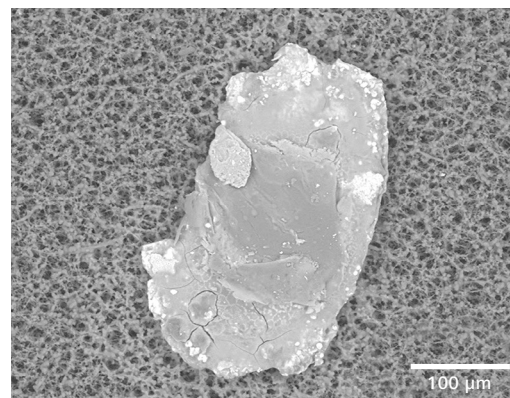
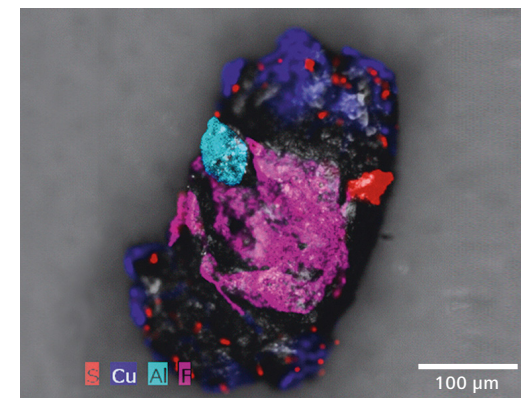

Image of the same metallic particle from an electron microscope



Overlay of the images from both systems; chemical element composition via EDX analysis; graphical EDX overlay prepared with Bruker Esprit software

Expand Your Possibilities

- › In Brief
- › The Advantages
- › The Applications
- › **The System**
- › Technology and Details
- › Service

Correlative Microscopy with ZEISS Axio Imager 2: Bridging the Micro and Nano World

Are you looking for a way to combine imaging and analytical methods effectively?

Shuttle & Find offers precisely this: An easy-to-use, highly productive workflow from a light to an electron microscope – and vice versa.

The workflow between the two systems has never been so easy. The precise recall of regions of interest enhances productivity. Instead of wasting valuable time searching, you now gain new insights into your samples with a few mouse clicks. Regions of interest, marked on one system, you can instantly relocate on the other system. Open up new dimensions of information in numerous material analysis applications. Absolutely reproducible.

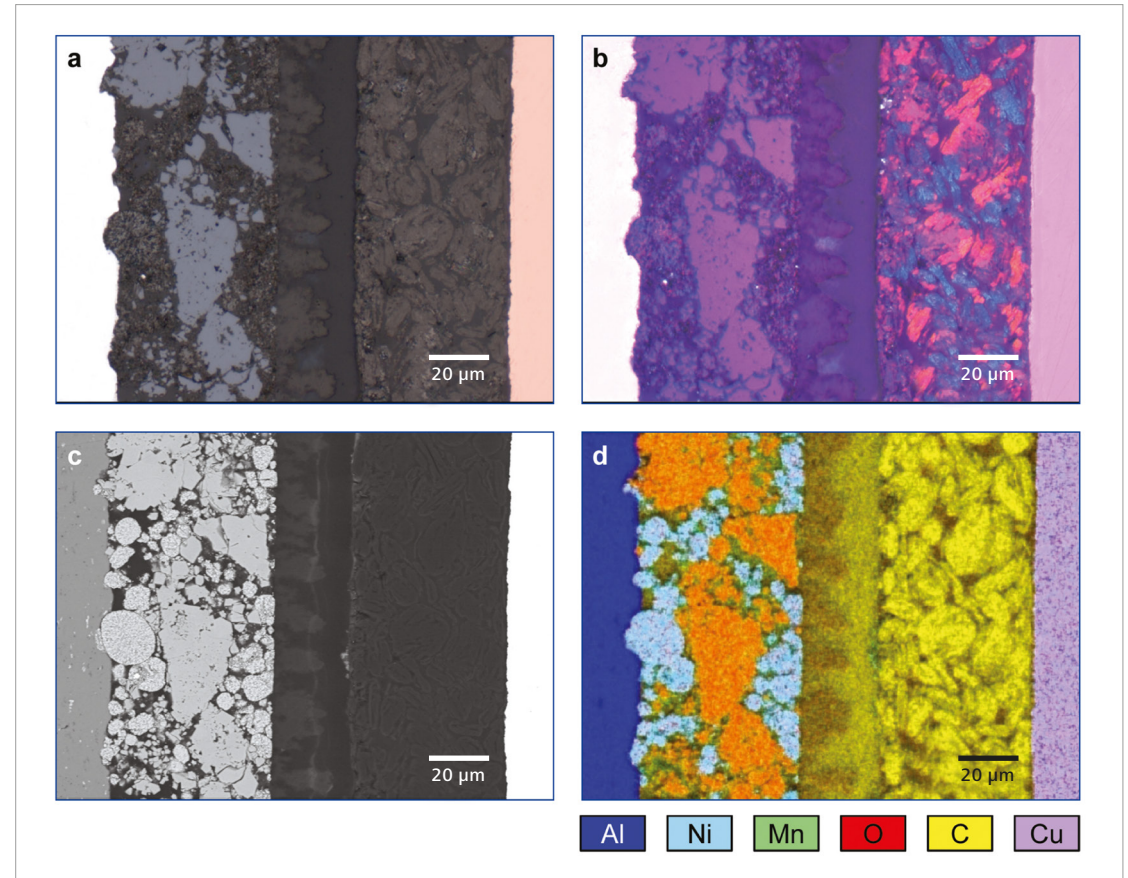

CLEM (Correlative Light and Electron Microscopy) image of a region of interest from an aged Li-ion battery with different contrasts of brightfield (a) and polarized light (b) in LM as well as BSE signal (c) and EDS mapping (d) in SEM.

Expand Your Possibilities

- › In Brief
- › The Advantages
- › The Applications
- › **The System**
- › Technology and Details
- › Service

Examinations in the fields of research and industrial production (e.g. surface examinations of reflective, low-contrast specimens such as metallographic specimens and polished or textured wafers) require a fast focusing system that ensures high precision levels of max. 0.3 times the objective's depth of field. This requirement can be easily met by combining your Axio Imager 2 with the Auto Focus system to benefit from fast and accurate focusing across a wide capture range of up to 12,000 µm. The Auto Focus system is designed to work with reflected light and transmitted light in brightfield, darkfield, polarized light and DIC.

How it Works

The objective guides the structured light produced by an LED in the Auto Focus system onto the specimen, with the specimen's surface reflecting it back. During this process, Auto Focus permanently analyses the signal and derives the appropriate control signals for the focus drive, to bring the surface into focus. The Auto Focus sensor detects changes and deviations in the focus position and compensates them automatically. The Auto Focus system comes with three different modes corresponding to different specimen characteristics (reflective/partially reflective/diffuse) and with three different precision levels (precision/balance/speed).

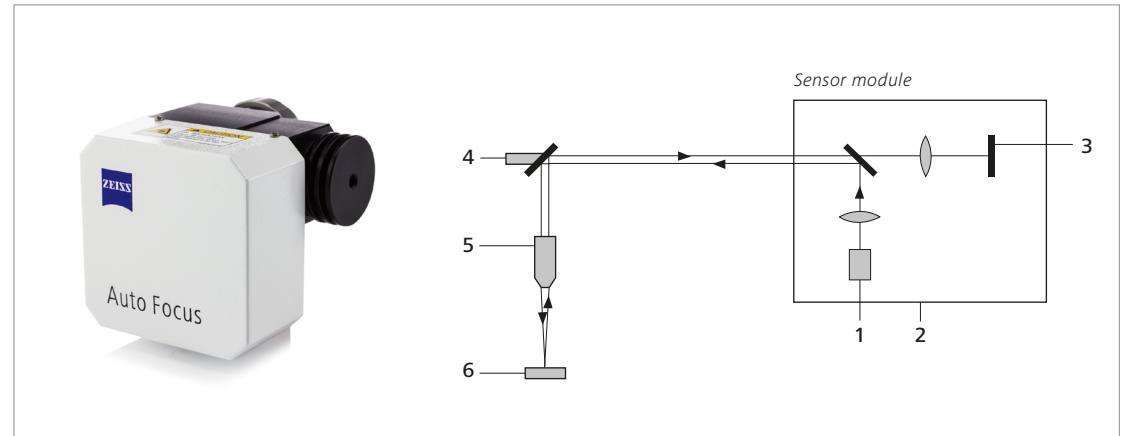

How the Auto Focus system works: 1) LED 2) Sensor module 3) Sensor 4) Beam splitter 5) Objective 6) Specimen

Objective magnification	Max. capture range in µm (reflective plain surface)	Maximum precision of focus position (accuracy) (~0.3 times the objective's depth of field), in µm	Minimum size of the object to be brought into focus, in µm
1.25x	>12000	~170.00	~2000
2.5x	>10000	~42.00	~1000
5x	>10000	~8.90	~500
10x	>8000	~2.50	~250
20x	>4000	~0.60	~125
50x	>700	~0.25	~50
100x	>150	~0.20	~25

Your Flexible Choice of Components

- › In Brief
- › The Advantages
- › The Applications
- › **The System**
- › Technology and Details
- › Service

1 Microscope

- Axio Imager.A2m (encoded)
- Axio Imager.D2m (encoded, partly motorizable)
- Axio Imager.M2m (motorizable, TL manual)
- Axio Imager.Z2m (motorizable, TL motorized)

2 Objectives

Reflected Light

- EC EPIPLAN
- EC Epiplan-NEOFLUAR
- EC Epiplan-APOCHROMAT

Transmitted Light

- N-ACHROPLAN
- EC Plan-NEOFLUAR
- Plan-APOCHROMAT
- C-APOCHROMAT
- FLUAR

Long Working Distance

- LD EPIPLAN
- LD EC Epiplan-NEOFLUAR

3 Illumination

Reflected Light

- MicroLED
- VisLED
- Halogen
- HBO / HXP

Transmitted Light

- MicroLED
- VisLED
- Halogen



4 Cameras

- AxioCam ICc 5
- AxioCam ICc 1
- AxioCam 105
- AxioCam 503
- AxioCam 506
- AxioCam 512



5 Software

- ZEN 2 core
- ZEN 2 starter
- AxioVision
- AxioVision LE

6 Accessories

- Auto Focus
- Linkam heating- and cooling stages
- Focus Linear Sensor
- Correlative Microscopy

System Overview

- › In Brief
- › The Advantages
- › The Applications
- › **The System**
- › Technology and Details
- › Service

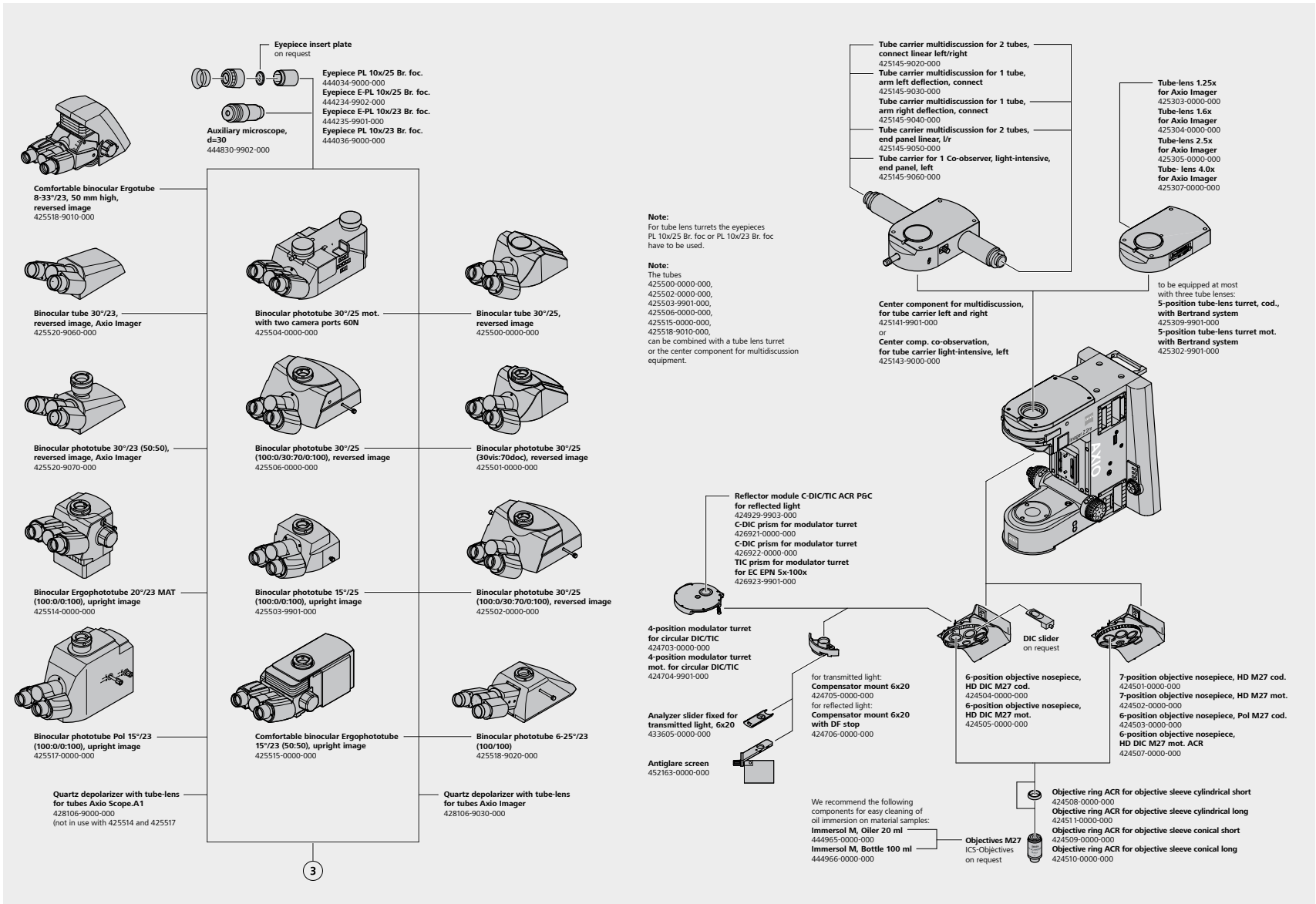

System Overview

- › In Brief
- › The Advantages
- › The Applications
- › The System
- › Technology and Details
- › Service

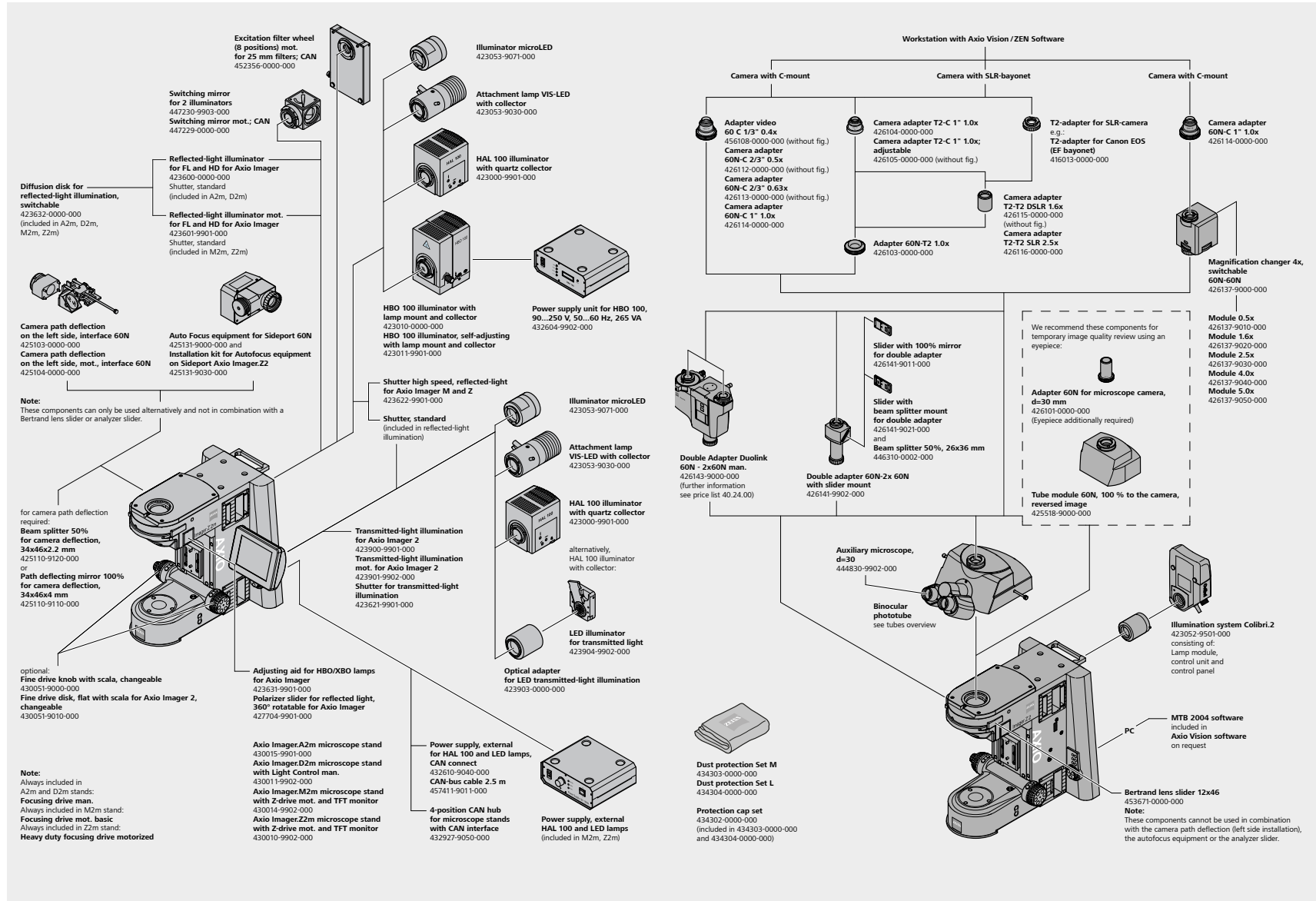

Technical Specifications

- › In Brief
- › The Advantages
- › The Applications
- › **The System**
- › Technology and Details
- › Service

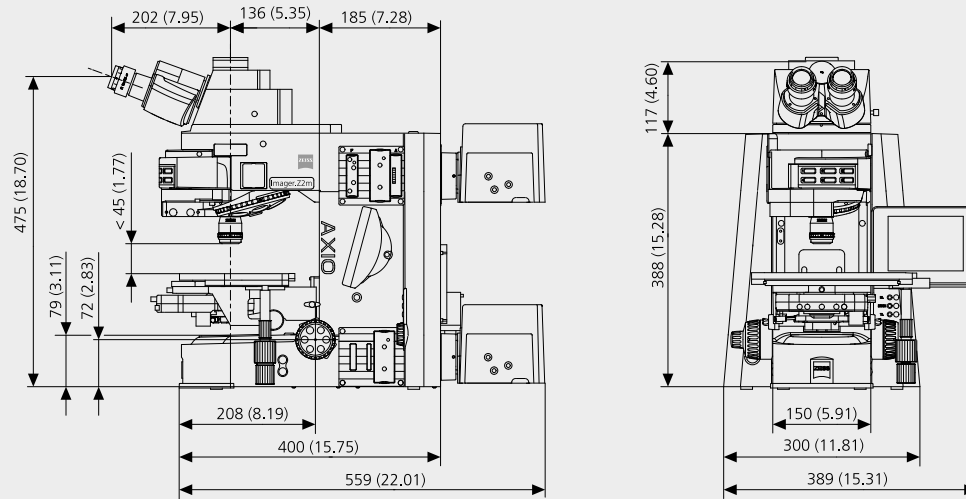

Stand	Axio Imager.A2m	Axio Imager.M2m	Axio Imager.D2m	Axio Imager.Z2m
Contrast Manager		●		●
Light Manager	●	●	●	●
TFT-Display		●		●
Remote Control		○ (Docking Station)		○ (Docking Station)

- Included
- Optional

Technical Specifications

- › In Brief
- › The Advantages
- › The Applications
- › The System
- › **Technology and Details**
- › Service

Dimensions (width x depth x height)

Axio Imager stand, manual with HBO 100	approx. 300 mm x 721 mm x 505 mm
Axio Imager stand, motorized with HBO 100 and TFT display	approx. 390 mm x 721 mm x 505 mm

Weight

Axio Imager, manual/motorized (dependent on equipment)	approx. 18 to 40 kg
--------------------------------------------------------	---------------------

Ambient Conditions Transport (in packaging):

Permissible ambient temperature	-40 to +70 °C
---------------------------------	---------------

Storage

Permissible ambient temperature	+10 to +40°C
Permissible relative humidity (no condensation)	max. 75% at 35 °C

Operation

Permissible ambient temperature	+10 to +40 °C
Permissible relative humidity	max. 75% at 35 °C
Atmospheric pressure	800 hPa to 1060 hPa
Altitude	max. 2000 m
Pollution degree	2

Technical Specifications

- › In Brief
- › The Advantages
- › The Applications
- › The System
- › **Technology and Details**
- › Service

Operating data for coded Axio Imager, equipped with an integrated power supply or motorized Axio Imager using the VP232-2 external power supply

Operating environment	Closed room
Protection Class	I
Protection Type	IP 20
Electrical safety	in compliance with DIN EN 61010-1 (IEC 61010-1) including CSA and UL directives
Overvoltage category	II
Radio interference suppression	in accordance with EN 55011 Class B
Noise immunity	in accordance with DIN EN 61326 -1
Line voltage for integrated power supply	100 to 127 and 200 to 240 V \pm 10 % Change of line voltage setting is not required!
Line voltage for external power supply VP232-2	100 to 240 V \pm 10 %
Line frequency	50/60 Hz
Power consumption of coded Axio Imager	max. 260 VA
Power consumption of Axio Imager, motorized	max. 190 VA
LED illuminator	400 to 700 nm, peak at 460 nm
Attachment lamp VIS-LED	400 to 700 nm, peak at 460 nm

Transformer HBO 100

Operating environment	Closed room
Protection Class	I
Protection Type	IP 20
Line voltage	100 VAC ... 240 VAC
Line frequency	50/60 Hz
Power consumption when HBO 100 is used	155 VA

Fuses in Accordance with IEC 127

Axio Imager microscope stand, manual	T 5.0 A/H / 250V, 5x20 mm
Power supply VP232-2 for Axio Imager, mot.	T 4.0 A / 250V, 5x20 mm
Transformer HBO 100	T 2.0 A/H, 5x20 mm

Technical Specifications

- › In Brief
- › The Advantages
- › The Applications
- › The System
- › **Technology and Details**
- › Service

Light Sources

Halogen lamp	12 V/100 W
Adjustment of light source	continuous, approx. 0.7 to 12 V
Mercury vapor short-arc lamp	HBO 103 W/2
Power consumption of HBO 103 W/2	100 W

Axio Imager, coded

Stand with manual stage focusing	Coarse drive	approx. 2 mm/revolution
	Fine drive	approx. 1/10 gear transmission ratio
	Lifting range	max. 25 mm
	Height stop	mechanically adjustable
Achromatic-aplanatic universal condenser 0.9 H D Ph DIC with swivel-type front lens, achromatic-aplanatic 0.9 DIC	for objective magnifications Vobj. < 10x	front lens 0.9 swiveled out
	for objective magnifications Vobj. ≥ 10x	front lens 0.9 swiveled in 8 position turret disc
Objective change	Manually	via 6-position or 7 position nosepiece, HD or HD DIC M27
Change of method modules	Manually	via 6-position reflector turret

Axio Imager, motorized

Stand with motorized stage focusing	Mean step size of stepper motor	25 nm (Axio Imager.M2)
		10 nm ±10 (Axio Imager.Z2)
	Quick lowering/lifting of stage	10 mm
	Lifting range	25 mm
	Height stop	electronic
Achromatic-aplanatic universal condenser 0.9 H D Ph DIC, mot. with swivel-type front lens, achromatic-aplanatic 0.9 DIC	for objective magnifications Vobj. < 10x	front lens 0.9 swiveled out
	for objective magnifications Vobj. ≥ 10x	front lens 0.9 swiveled in 8 position turret disc
Objective change	Manually or motorized	via 6 position or 7 position nosepiece
Change of method modules	Manually	via 6 position reflector turret
	Motorized	via 6 position or 10 position reflector turret
	Manually/motorized	via DIC or C-DIC modulator turret
High-performance focus for scanning stages	Applicable for specimens weighing up to 5 kg	

Count on Service in the True Sense of the Word

- › In Brief
- › The Advantages
- › The Applications
- › The System
- › Technology and Details
- › **Service**

Because the ZEISS microscope system is one of your most important tools, we make sure it is always ready to perform. What's more, we'll see to it that you are employing all the options that get the best from your microscope. You can choose from a range of service products, each delivered by highly qualified ZEISS specialists who will support you long beyond the purchase of your system. Our aim is to enable you to experience those special moments that inspire your work.

Repair. Maintain. Optimize.

Attain maximum uptime with your microscope. A ZEISS Protect Service Agreement lets you budget for operating costs, all the while reducing costly downtime and achieving the best results through the improved performance of your system. Choose from service agreements designed to give you a range of options and control levels. We'll work with you to select the service program that addresses your system needs and usage requirements, in line with your organization's standard practices.

Our service on-demand also brings you distinct advantages. ZEISS service staff will analyze issues at hand and resolve them – whether using remote maintenance software or working on site.

Enhance Your Microscope System.

Your ZEISS microscope system is designed for a variety of updates: open interfaces allow you to maintain a high technological level at all times. As a result you'll work more efficiently now, while extending the productive lifetime of your microscope as new update possibilities come on stream.

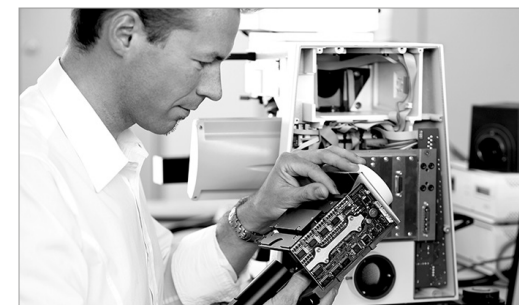

Profit from the optimized performance of your microscope system with services from ZEISS – now and for years to come.

>> www.zeiss.com/microservice



Carl Zeiss Microscopy GmbH
07745 Jena, Germany
microscopy@zeiss.com
www.zeiss.com/axioimager-mat



Instruments
info@ctk-instruments.com
www.ctk-instruments.com
866-464-1005

